



# Jeep® Pocket Style® Fender Flares Set of 4

Set Part #10908-02

Rev-7 1/16/2014

For complete fitment info visit : [www.bushwacker.com](http://www.bushwacker.com)

## STEP 1 – PRIOR TO INSTALLATION

- A) Bushwacker only approves installing the flares according to these written instructions with the hardware provided. WARNING:** Failure to install according to these instructions will invalidate the warranty. This includes, but is not limited to using alternative installation methods, hardware, or materials. **DO NOT USE:** Loctite, SuperGlue, or similar products on the hardware or the flares.
- B) Fit:** Verify the fit of the flares to vehicle. (Some filing, sanding, or cutting may be necessary to ensure proper fit).
- C) Painting:** (Optional) if paint is desired it must be done prior to installing flares on vehicle. Clean outer surface with a good grade degreaser. **DO NOT USE LACQUER THINNER OR ENAMEL REDUCER AS A DEGREASER.** Wipe outer surface thoroughly with a tack rag prior to paint. Application of plastic adhesion promoter for ABS plastic as per your paint system manufacturer's recommendations is required. Paint flares using a high quality enamel, or polyurethane automotive paint. If painting edge trim (not recommended), use a flex additive.
- D) Performance:** Using larger Tires may increase the area required to turn the vehicle. Some Tire/Rim combinations may require lowering bump stops and or installing steering stops to prevent tire from contacting flare.
- E) Exhaust System:** Modifications may be necessary to maintain a minimum 4" clearance between flares and exhaust pipes. (Exhaust gases should not vent directly onto flares)
- F) Metal Protection:** All exposed fasteners and bare metal should be treated with rust resistant paint BEFORE installing flares. Spray inner fender wells with undercoating AFTER flare attachments have been completed.
- G) Decals:** Flares may interfere with existing decals on vehicle. If you wish, remove decals prior to installation of flares.







## TOOLS FOR EASY INSTALLATION:

- #2 Philips Bit
- 5/16" Wrench
- 5/16" Socket
- 7/16" Wrench
- 7/16" Socket
- Socket Driver
- Pry Bar or Claw Hammer

## LIMITED LIFETIME WARRANTY AGAINST ANY MANUFACTURING DEFECTS

- To claim a warranty, you must provide Proof of Purchase.

## Included in Hardware Kit:

- |    |   |    |   |    |   |    |   |    |   |    |   |    |   |
|----|---|----|---|----|---|----|---|----|---|----|---|----|---|
| 1. |  | 2. |  | 3. |  | 4. |  | 5. |  | 6. |  | 7. |  |
|    | ET1-0002,<br>Edge Trim Tool,<br>1 pc  |    | GP1-0005,<br>Large Wiper Style<br>Edge Trim,<br>246 inches                          |    | NU1-0010,<br>M5 x.8 Serrated<br>Flange Hex Nut,<br>18 pcs                           |    | SP1-0009,<br>3/8" x 5/8" x .187"<br>Neo Black Spacer,<br>28 pcs                     |    | SW1-0022,<br>T-30 Torx Bit,<br>1 pc   |    | SW1-0040,<br>M5-.8 x 35mm<br>SS Bttnhd Screw,<br>28 pcs                               |    | WA1-0007,<br>.203x.625x.04<br>#10 SS Washer,<br>28 pcs                                |

# Flare Installation Procedures:

## STEP 2 - Edge Trim Installation:

- A) Remove factory installed edge trim when necessary.
- B) Peel two to three inches of red vinyl backing away from edge trim tape. Applying the adhesive side of the edge trim to the inner side of the flare, affix the edge trim to the top edge of the flare (the portion that comes in contact with the vehicle). **See Illustration #1**
- C) Press edge trim into place along the top edge of the flare in one-foot increments, pulling red vinyl backing free as you continue to work your way around the top edge of the flare

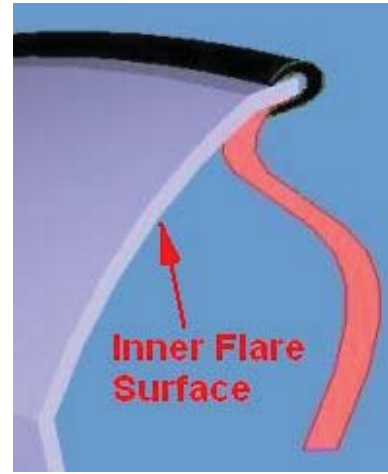

**Illustration #1**

## STEP 3 - Preparing the Work Area:

- A) Remove the rear wheel well skirting. Using a pry bar or claw hammer to release the Christmas tree fasteners. Save for re-installation.
- B) Remove the marker light from the front fender flare.
- C) Remove the factory fender flares and stone guards.

## STEP 4 - Flare & Stoneguard Installation:

- A) For the Front Flare, place a supplied washer on a supplied screw and place screw through hole in pocket. Place a 3/8" thick spacer on the screw from the back side of the pocket.
- B) Holding the flare into position on the fender, insert the screws through the factory holes in the fender with the supplied screws. Start a supplied nut on screw but do not tighten until all screws have been installed. Use caution: Do not over tighten the screws. Over tightening will not allow the flare to expand and contract with temperature changes after the flare is installed.
- C) Install the marker light into the pocket formed in the flare.
- D) Fasten the stone guard to the vehicle with the factory screws that were previously removed.
- E) For the Rear Flare, repeat steps (A) and (B). Use the supplied nuts in the positions that do not have a threaded insert in the vehicle body.

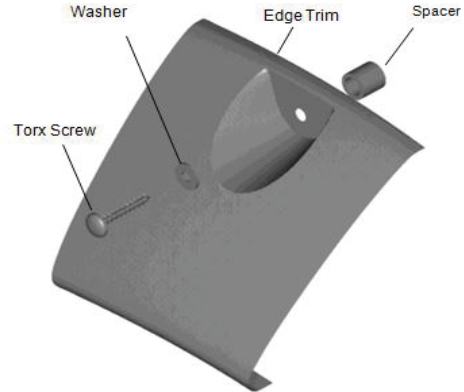

**Illustration #2**

**STEP 5 - Edge Trim Tool:**

**A)** Using supplied Edge Trim Tool, seat edge trim against vehicle by hooking curved end under edge trim at one end of flare. Next, slide around outer edge of flare to the other end.

**See Illustration #3.**

**B)** Using flat end of supplied Edge Trim Tool, seat edge trim against flare by inserting straight end between edge trim and flare at one end. Next, slide around entire edge to the other end. **See Illustration #4.**



**Illustration #3**



**Illustration #4**