



## STEP 1 – PRIOR TO INSTALLATION

- A) Bushwacker only** approves installing the flares according to these written instructions with the hardware provided. **WARNING:** Failure to install according to these instructions will invalidate the warranty. This includes, but is not limited to using alternative installation methods, hardware, or materials. **DO NOT USE:** Loctite, SuperGlue, or similar products on the hardware or the flares.
- B) Fit:** Verify the fit of the flares to vehicle. (Some filing, sanding, or cutting may be necessary to ensure proper fit).
- C) Painting:** (Optional) if paint is desired it must be done prior to installing flares on vehicle. Clean outer surface with a good grade degreaser. **DO NOT USE LACQUER THINNER OR ENAMEL REDUCER AS A DEGREASER.** Wipe outer surface thoroughly with a tack rag prior to paint. Application of plastic adhesion promoter for ABS plastic as per your paint system manufacturer's recommendations is required. Paint flares using a high quality enamel, or polyurethane automotive paint. If painting edge trim (not recommended), use a flex additive.
- D) Performance:** Using larger Tires may increase the area required to turn the vehicle. Some Tire/Rim combinations may require lowering bump stops and or installing steering stops to prevent tire from contacting flare.
- E) Exhaust System:** Modifications may be necessary to maintain a minimum 4" clearance between flares and exhaust pipes. (Exhaust gases should not vent directly onto flares)
- F) Metal Protection:** All exposed fasteners and bare metal should be treated with rust resistant paint **BEFORE** installing flares. Spray inner fender wells with undercoating **AFTER** flare attachments have been completed.
- G) Decals:** Flares may interfere with existing decals on vehicle. If you wish, remove decals prior to installation of flares.

## Toyota Cut-Out™ Fender Flares Front Pair

Front Part #31009-11

Rev-2 9/20/2013

For complete fitment info visit : [www.bushwacker.com](http://www.bushwacker.com)





### TOOLS FOR EASY INSTALLATION:

- 3/8" Drill Motor
- 1/4" Drill Bit
- #2 Phillips Driver Bit
- 10mm Wrench
- 8mm Wrench
- Sheet Metal Cutting Tool (Hacksaw, Saber Saw or Air Chisel)
- Hammer
- C-Clamp or Vise Grips
- Marking Pen
- Straight Edge (Flexible)
- Jack
- Jack Stands (2)

### LIMITED LIFETIME WARRANTY AGAINST ANY MANUFACTURING DEFECTS

- To claim a warranty, you must provide Proof of Purchase.

## Included in Hardware Kit:

- |    |  |    |   |    |   |    |   |
|----|--|----|---|----|---|----|---|
| 1. |  | 2. |  | 3. |  | 4. |  |
|    | GP1-0015,<br>Gimp  |    | SW1-0066,<br>#8 x 5/8" Phillips<br>PH Drill Screw,                                  |    | SC1-0001,<br>Black FF<br>Snap Cap,  |    | SC1-0003,<br>3/32" FF Plastic<br>Cup Washer,  |
|    | 15ft.  |    | 15 pcs  |    | 22 pcs  |    | 22 pcs  |

# Flare Installation Procedures:

## STEP 2 - Disassembly (Front):

- A) Jack up vehicle and use jack stands.
- B) Remove wheel and wheel well trim (if so equipped).
- C) Remove (3) mudflap retaining screws.
- D) Remove all screws retaining wheel well liner to fender lip. Do not remove liner. Bend rear portion of wheel well liner forward.

## STEP 3 - Cutting Sheet Metal (Front):

- A) Mark a line 1" out from existing wheel well opening (lower rear leg only). See Photo #1
- B) Mark a straight line from Step 3A to point tangent to opening. See Photo #2.
- C) Cut along line drawn in Step 3B.
- D) Hammer back body seam. See Photo #3
- E) Trim wheel well liner at lower rear. See Photo #4
- F) Tuck wheel well liner behind last original mounting point on fender lip. Photo #4 (circle area). Secure wheel well liner with original mounting screws. The mounting point at inside rear will be secured by using a supplied drill screw. See Photo #5 on page #3 of these instructions.
- G) Secure mud flap with original fastener on inside mounting point. At top center of mud flap and sheet metal secure with a supplied drill screw. See Photo #6 on page #3 of these instructions.



Photo #1



Photo #2

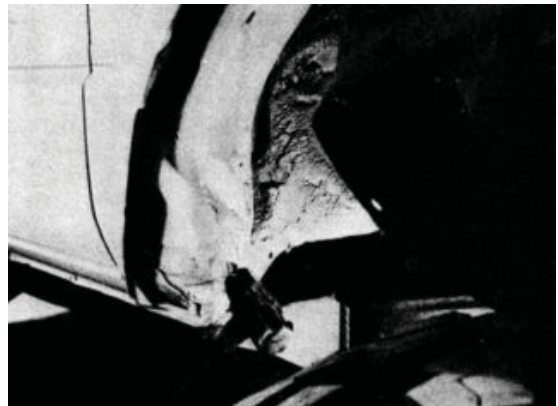

Photo #3



Photo #4

#### STEP 4 - Fender Flare Installation (Front):

Note: A #2 Phillips Driver bit is needed to install drill screws

**A)** Fit flare tightly into fender well opening, making sure mud flap is on outside of flare. With everything ready, drill screw last pocket on rear leg first (use indents in flare pockets as a guide). Don't forget the cap washer under rivet head. Note: Cap washers are applied to drill screw pockets only. Next, drill screw first pocket on front leg of flare. Drill screw in an alternating pattern front to rear until all outer pockets are secured. On underside of flare and fender lip secure with drill screws at (5) points. See Photo #7. Complete flare attachment with drill screws on underside rear leg. See Illustration #A-1 on page #4 of these instructions as a hardware installation guide.

**B)** Secure mud flap and flare near original mounting hole with a drill screw. (Use a back up washer on inside of flare to catch drill screw). See Photo #8

**C)** Press trim caps onto outer flare cap washers.



Photo #5

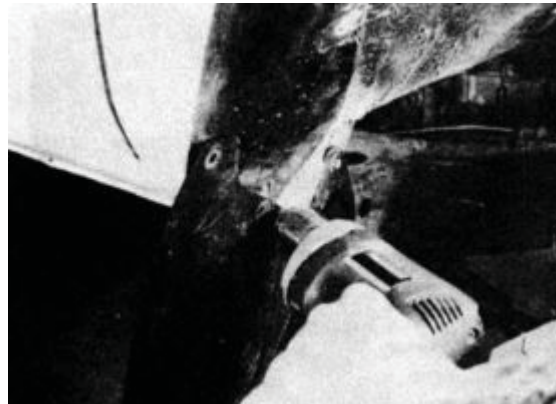

Photo #6



Photo #7



Photo #8

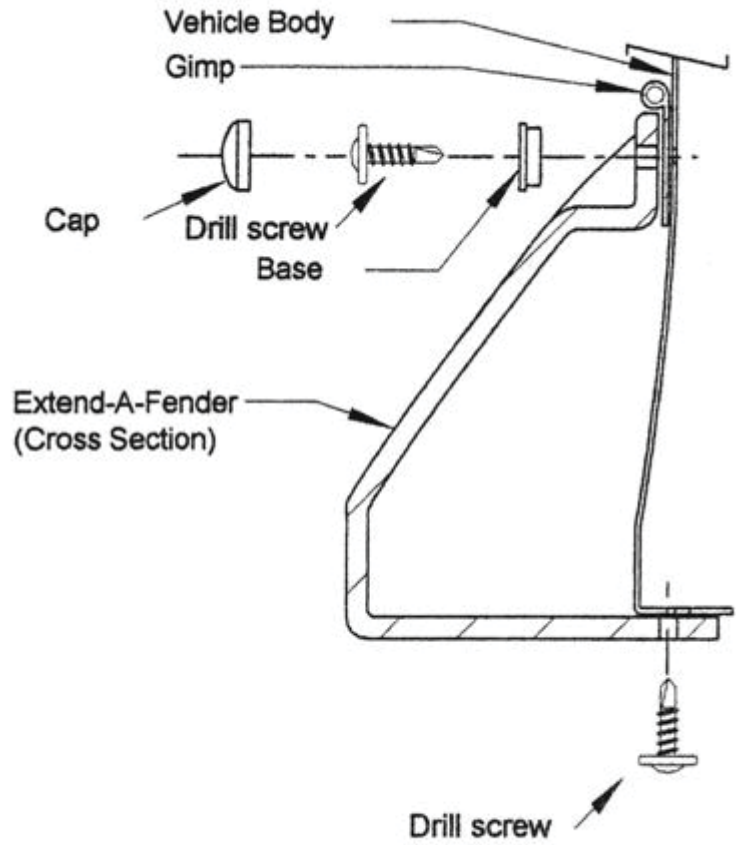

Illustration #A-1