

STEP 1 – PRIOR TO INSTALLATION

- A) Bushwacker only** approves installing the flares according to these written instructions with the hardware provided. **WARNING:** Failure to install according to these instructions will invalidate the warranty. This includes, but is not limited to using alternative installation methods, hardware, or materials. **DO NOT USE:** Loctite, SuperGlue, or similar products on the hardware or the flares.
- B) Fit:** Verify the fit of the flares to vehicle. (Some filing, sanding, or cutting may be necessary to ensure proper fit).
- C) Painting:** (Optional) if paint is desired it must be done prior to installing flares on vehicle. Clean outer surface with a good grade degreaser. **DO NOT USE LACQUER THINNER OR ENAMEL REDUCER AS A DEGREASER.** Wipe outer surface thoroughly with a tack rag prior to paint. Application of plastic adhesion promoter for ABS plastic as per your paint system manufacturer's recommendations is required. Paint flares using a high quality enamel, or polyurethane automotive paint. If painting edge trim (not recommended), use a flex additive.
- D) Performance:** Using larger Tires may increase the area required to turn the vehicle. Some Tire/Rim combinations may require lowering bump stops and or installing steering stops to prevent tire from contacting flare.
- E) Exhaust System:** Modifications may be necessary to maintain a minimum 4" clearance between flares and exhaust pipes. (Exhaust gases should not vent directly onto flares)
- F) Metal Protection:** All exposed fasteners and bare metal should be treated with rust resistant paint **BEFORE** installing flares. Spray inner fender wells with undercoating **AFTER** flare attachments have been completed.
- G) Decals:** Flares may interfere with existing decals on vehicle. If you wish, remove decals prior to installation of flares.

Chevrolet Cut-Out™ Fender Flares Front Pair

Front Part #40097-02

Rev-7 11/19/2013

For complete fitment info visit : www.bushwacker.com

TOOLS FOR EASY INSTALLATION:

- 1/2" Wrench
- 7mm Socket
- 3/8" Ratchet
- Electric Drill
- 3/32" Drill Bit
- #2 Phillips Driver
- Grease Pencil
- Body Filler Spreader
- Sledge Hammer
- Pry Tool
- String or Twine
- Masking Tape

LIMITED LIFETIME WARRANTY AGAINST ANY MANUFACTURING DEFECTS

- To claim a warranty, you must provide Proof of Purchase.

Included in Hardware Kit:

- 

SW1-0056,
#8 x 3/4"
PH Screw,
18 pcs
- 

WA1-0017,
1/4 x 1-1/4" Black
Fender Washer
4 pcs
- 

SW1-0067,
5/16 x 18 x 3/8"
SS Torx Screw,
18 pcs
- 

WA1-0012,
.320 x .700 x .03
SS Washer,
18 pcs
- 

NU1-0019,
5/16-18 Jam Fin.
Nylock Nut,
18 pcs
- 

SW1-0052,
T-45 Torx Bit,
1 pc
- 

ET1-0002,
Edge Trim Tool,
1 pc
- 

GP1-0008,
Duro (NC02/S 70)
Edge Trim,
160 inches

STEP 2 - EDGE TRIM INSTALLATION

A. Peel two to three inches of red vinyl backing away from Edge Trim (GP1-0008) tape. Applying the adhesive side of the edge trim to the inner side of the flare, affix the edge trim to the top edge of the flare (the portion that comes in contact with the vehicle).

B. Press edge trim into place along the top edge of the flare in one-foot increments, pulling red vinyl backing free as you continue to work your way around the top edge of the flare.



Pocket Hardware Installation Procedures:



Put a Washer (WA1-0012) on each Bolt (SW1-0059).



Put each Bolt/Washer combination through a pocket hole in the flare, Bolt head and Washer on the outside.



Place a Nut (NU1-0019) over the end of each Bolt and tighten, using a 1/2" wrench for the Nut and the supplied Torx Bit (SW1-0052) for the Bolt. Repeat for remaining pockets.

Front Flare Installation Procedures (Driver's Side):

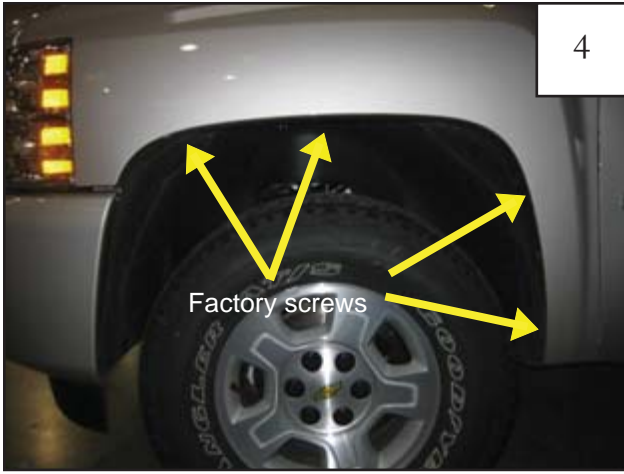

Using a 7mm socket, remove four factory screws from wheel well and save for reinstallation.



Support vehicle and remove tire.



Using a pry tool, remove plastic factory fastener from wheel well liner located above the two factory screw locations.



Pull back plastic shield and tie it to the axle with string or twine to keep it out of the way.

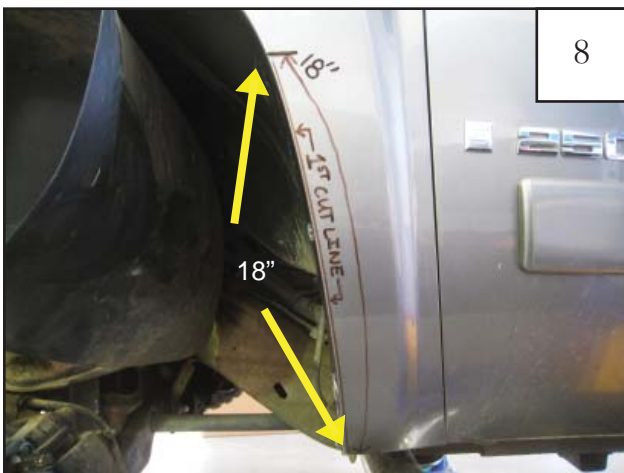

At rearward side of wheel well measure up 18" from the bottom edge of fender and mark vehicle with a grease pencil.

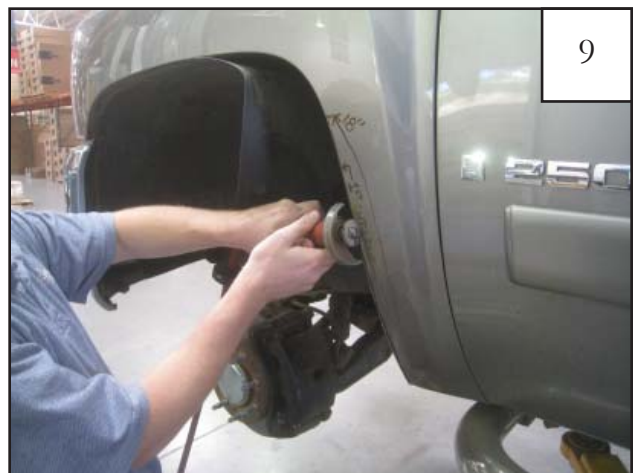

Cut along the outside of fender to 18" mark. See picture in step 10.

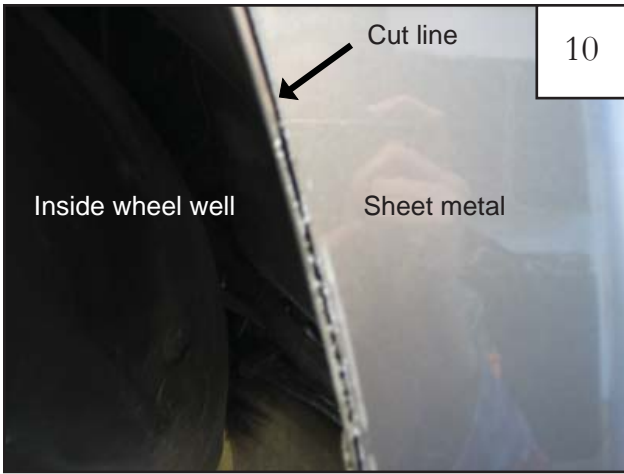

Cut into sheet metal along the edge of wheel well.

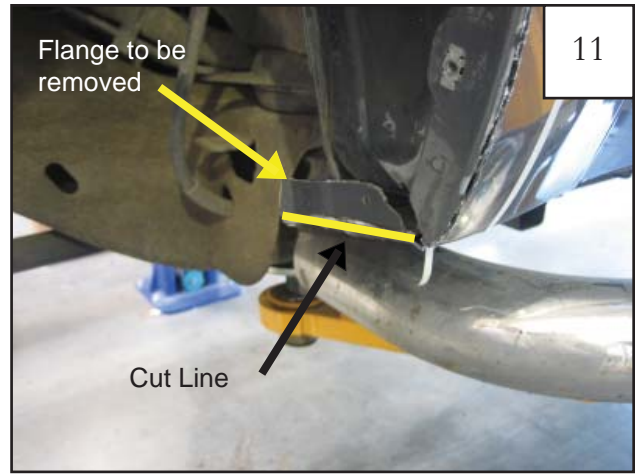

Cut flange off of lower rearward edge of inside of wheel well.

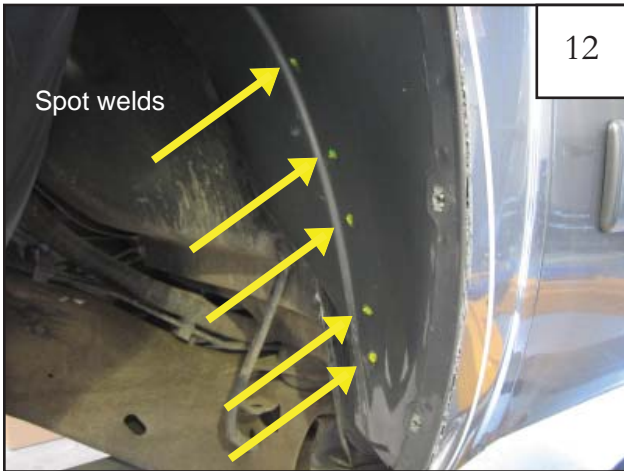

Drill through spot weld locations shown here to separate metal inner wheel well from fender.



Bend inner fender metal away from fender.

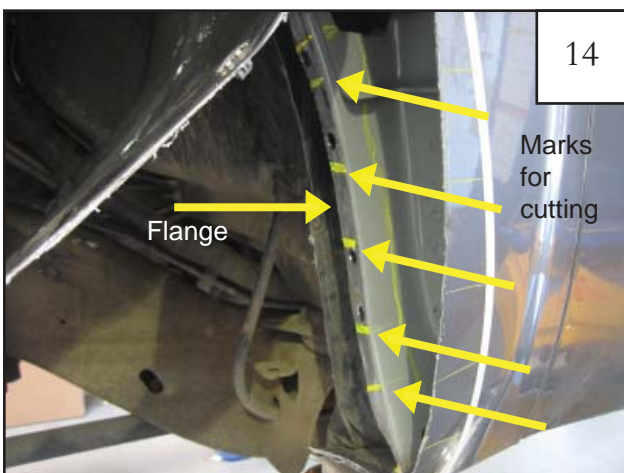

Mark the flange on the inner fender support structure approximately every 2".

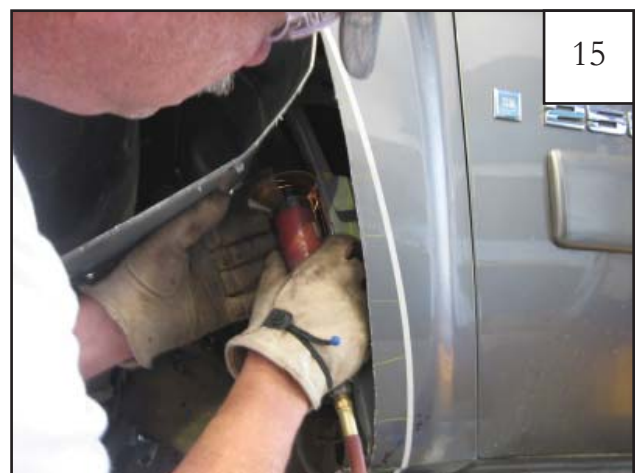

Cut the inner structure on marks made in previous step.



16

Bend lip straight with pliers between cuts made in previous step.

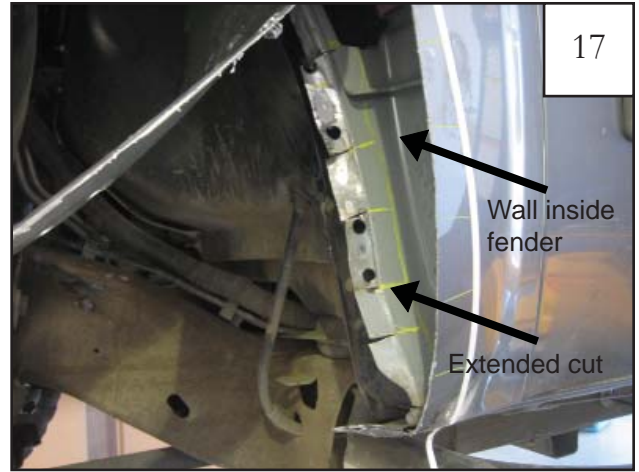

17

After bending flange of inner fender support straight, make the cuts go further to meet with the wall inside the fender.



18

To prevent paint damage, insert plastic spacer between fender and door. This will keep the fender from hitting the door edge while pounding back sheet metal in the next few steps.



19

Cut off outlined tab to make bend in the next step easier.

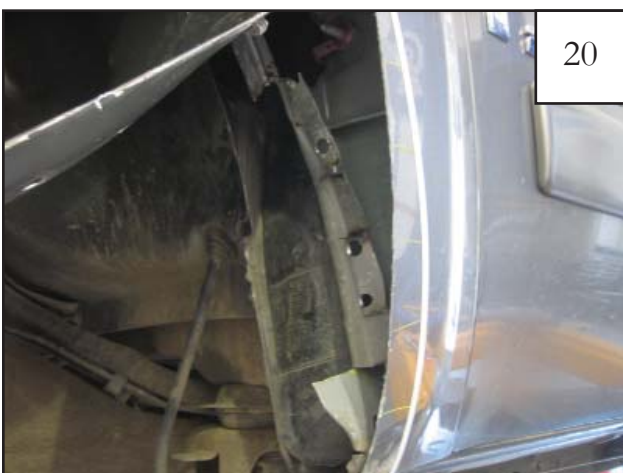

20

Bend inner support over and use a hammer to flatten against wall inside fender.

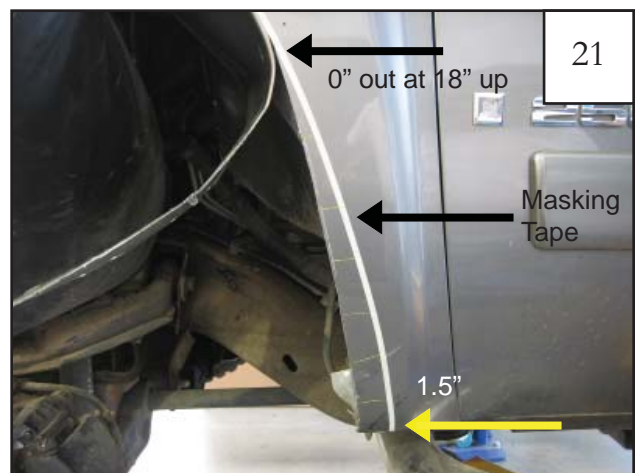

21

At the bottom of cut fender, measure 1.5" toward door seam and make a mark. Use masking tape to created a reference line from mark at bottom up to the 18" point.



Cut fender approximately every 2" up to edge of masking tape.



Bend lowest two metal tabs outward.

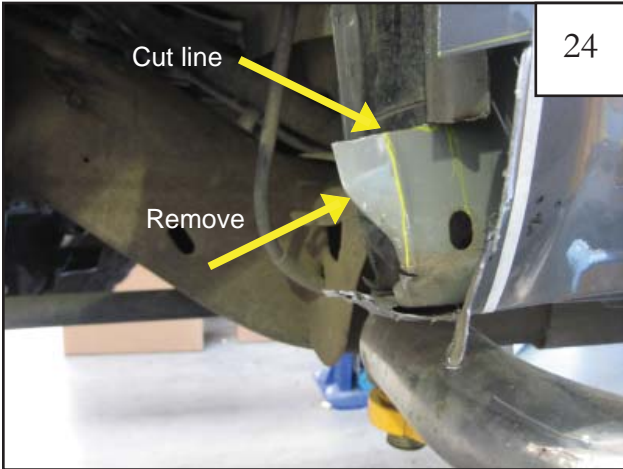

Mark the remaining inner metal at cut line and remove outermost section.



Bend remaining metal back even with other tabs.



Cut off metal that overlaps outer sheet metal.



Mark inner pinch seam at location shown.



28
Cut pinch seam at mark made in previous step. Bend flange back even with firewall.

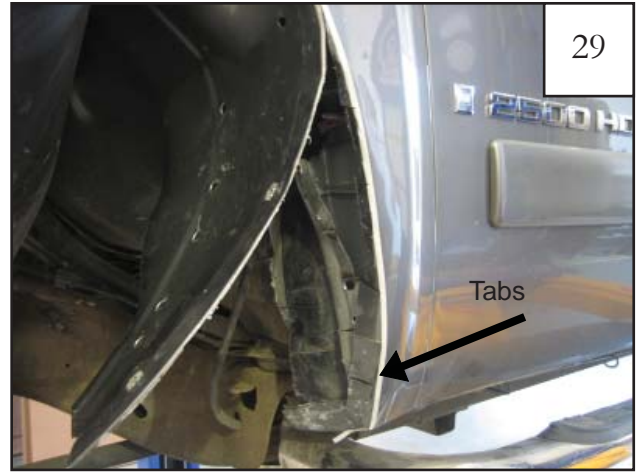

29
Pound back metal of firewall below cut made in previous step with a sledge hammer. Bend tabs bent outward in step 23 into wheel well.

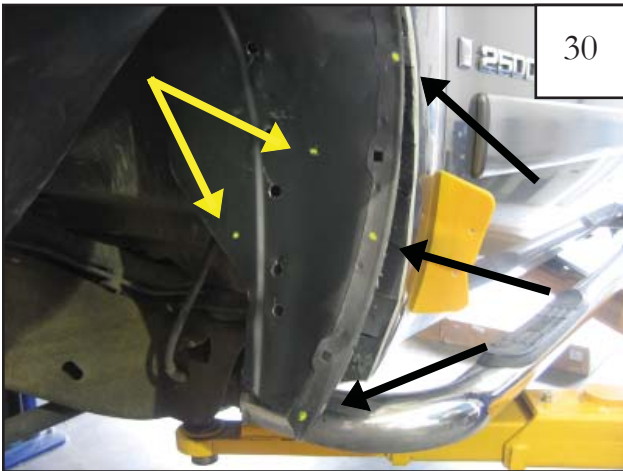

30
Mark five locations in approximate places shown so metal wheel well liner can be reattached. Hold flare to vehicle to ensure that marks are at least an inch away from holes in the flare.



31
With 3/32" drill bit, drill through mark and the bent tabs of metal behind them for three locations along edge of wheel well.



32
Starting with the top location, fasten inner fender metal to bent tabs of outer fender with Screw (SW1-0056)s through holes drilled in last step (3 locations).

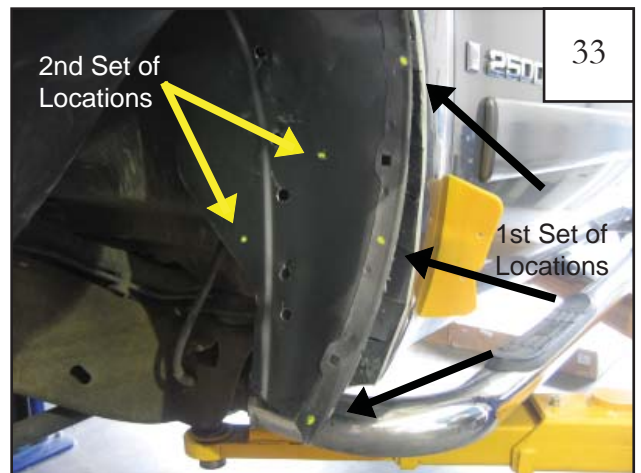

33
Repeat steps 31 & 32 for two locations further inside wheel well.



Put splash shield back in place. With a 3/32" bit, drill a hole 3" in from corner of fender and 1" up from bottom edge.

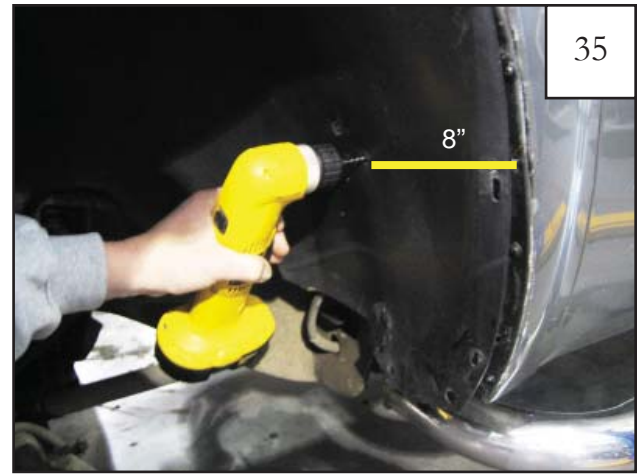

Using a 3/32" bit, drill a hole 8" in from hole in wheel well liner.

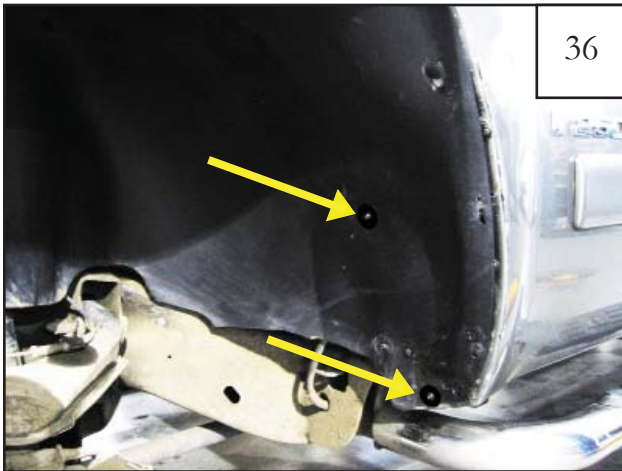

Fasten wheel well liner to body with Screw (SW1-0056) and Washer (WA1-0017) through the holes drilled in the previous two steps.

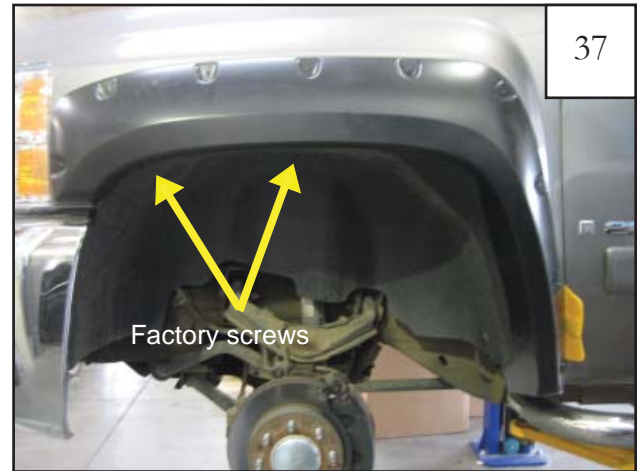

Using a 7mm socket reinstall two factory screws through flare, holes in splash shield, and into factory screw clips at top two locations.



At two locations in the rearward side of the flare, drill through hole in flare and into sheet metal of vehicle.



Install Screw (SW1-0056) through flare and into hole in sheet metal in both locations.



Reinstall wheel. Completed front flare installation.

Edge Trim Tool Procedures:

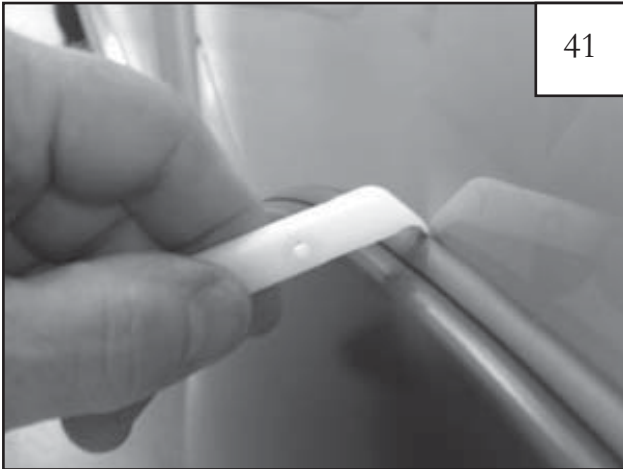

Using supplied Edge Trim Tool (ET1-0002), seat edge trim against vehicle by hooking curved end under edge trim at one end of flare. Next, slide around outer edge of flare to the other end.



Using flat end of supplied Edge Trim Tool (ET1-0002), seat edge trim against flare by inserting straight end between edge trim and flare at one end. Next, slide around entire edge to the other end.